



INSTALLATION GUIDE

THORNOVA PHOTOVOLTAIC MODULE

20241003



USER MANUAL

1. INTRODUCTION FOR USER MANUAL1

1.1 DISCLAIMER.....1

1.2 LIMITATION OF LIABILITY.....1

2. SAFETY PRECAUTIONS.....1

2.1 WARNING1

2.2 GENERAL SAFETY.....2

2.3 HANDLING SAFETY2

3. GENERAL INFORMATION.....3

3.1 Module Identification3

3.2 Power Performance3

4. STORAGE, TRASPOTATION AND DISMANTLING5

4.1 MARKINGS ON OUTER PACKAGING5

4.2 UNLOADING WARNING7

4.3 SECONDARY TRANSPORT AND WARNING.....8

4.4 STORAGE9

4.5 UNPACKING INTRODUCTION.....9

4.6 UNPACKING STEPS OF FRAMED DUAL-GLASS MODULE SERIES10

5. MODULE INSTALLATION12

5.1 PRECAUTIONARY MEASURES AND GENERAL SAFETY13

6. MOUNTING INSTALLATION.....16

6.1 MOUNTING METHOD: BOLTING19

6.2 MOUNTING METHOD: CLAMPING22

6.3 GROUNDING25

6.4 ELECTRICAL INSTALLATION28

6.5 WIRING.....29

Attachment 1: NAMING RULE31

1. INTRODUCTION FOR USER MANUAL

This Manual applies to the installation, maintenance and use of the solar modules manufactured by Yuncheng Solar USA (hereinafter referred to as “Thornova Solar”). Failure to follow these safety instructions could result in personal injury or property damage.

Installation and operation of solar modules require specialized skills, and only professional personnel can engage in the work. Please read the “Safety and Installation Instructions” carefully before using and operating the modules. The installer must inform the end customer (or consumer) of the above matters accordingly.

The term “Module” or “PV Module” in this Manual refers to one or more solar modules. Please keep this Manual for future reference.

1.1 DISCLAIMER

Thornova Solar reserves the rights to change this installation Manual without prior notice. Failure of the customer to follow the requirements outlined in this Manual during the installation of the module will result in the invalidity of product's limited warranty.

1.2 LIMITATION OF LIABILITY

Thornova Solar is not responsible for any form of damage, including but not limited to module operation and system installation error, and personnel injury, hurt, and property loss resulting from failure to follow the instructions in this Manual

2. SAFETY PRECAUTIONS

2.1 WARNING

Before installing, wiring, operating, or maintaining Thornova Solar modules, you should read and understand all safety precautions. Direct current (DC) is generated when the cells surface of the module is exposed to direct sunlight or other light sources, and direct contact with the live parts of the module, such as terminals,

may result in death of personnel whether connected to the module or not.

2.2 GENERAL SAFETY

All installation work must comply with the local codes and the relevant international electrical standards. Thornova Solar recommends that PV module installation is conducted by personnel with experience in PV system installation. Operation by personnel who are not familiar with the relevant safety procedures will be very dangerous.

Do NOT allow unauthorized persons to access the installation area or module storage area.

Do NOT install modules with damaged glass.

Do NOT disassemble or move any part of the module.

Do NOT artificially focus light on the module.

Do NOT connect or disconnect the module when it is energized or connected with an external power supply.

2.3 HANDLING SAFETY

Do NOT stand, walk on or lean on the module directly.



Do NOT damage or scratch the front or backside surfaces of the module.

Do NOT scratch the output cable or bend it with force. The insulation of output cable can break and may result in electricity leakage or shock.

Do NOT use water to extinguish fires of an electrical origin.

Do NOT install or handle modules when they are wet or during periods of high wind. At the installation site, take care to keep modules, and particularly their electrical contacts, clean and dry before installation. If connector cables are left in damp conditions, then the contacts may corrode. Any module with corroded contacts should not be used.

Please do NOT loosen or unscrew the PV module bolts. This may lead to a reduction of the module's load rating and potential damage from a fall.

Do NOT drop PV modules or allow objects to fall-down on the PV modules.

Do NOT touch the terminal box or the ends of the output cables (connectors) with bare hands under sunlight, regardless of whether the PV module is connected to or disconnected from the system.

3. GENERAL INFORMATION

3.1 Module Identification

Each module is labelled with one of 2 labels that provide the following information:

1. **Nameplate:** describes the product type, standard rated power, rated current, rated voltage, open-circuit voltage, short-circuit current under test conditions, certification labelling, maximum system voltage and other information.
2. **Serial Number:** Each component has a unique serial number. It is permanently cemented inside the component and is clearly visible from the top of the front of the component. This serial number is placed on the component before it is laminated. In addition, you can find an identical serial number on the side of the assembly nameplate.

3.2 Power Performance

Module electrical ratings are measured under Standard Test Conditions (STC) of 1000 W/m² irradiance, with an AM1.5 spectrum, and a cell temperature of 25°C. Detailed electrical and mechanical characteristics of Thornova Solar crystalline silicon PV modules can be found in datasheets. The main electrical characteristics at STC are also stated on each module label. Please refer to the datasheet or the product nameplate for the maximum system voltage.

Under certain conditions, a module may produce more current or voltage than its Standard Test Conditions rated power. As a result, electrical calculations and design must be performed by a qualified engineer or consultant.

Refer to the appropriate component datasheet for peak power (P_{max}) temperature coefficients, open circuit voltage (V_{oc}) temperature coefficients, and short circuit current (I_{sc}) temperature coefficients.

In determining the appropriate wire and fuse sizes, it is necessary to multiply the short-circuit current by 1.25

x 1.25 (i.e., multiply by 1.56 in total) according to local regulations. For double-sided modules, the short-circuit current is also related to the specific installation conditions. The current of a double-sided module varies with different mounting heights of the module and mounting surfaces with different reflectivity, so multiplied by 1.2 on top of 1.56. for double-sided modules mounted on roofs that are so close to the roof that double-sided gain is not possible, ignore the additional 1.2 times correction factor.

The selection of the specification of the overcurrent protective device must be made with reference to the following guidelines, the minimum overcurrent protective device specification is determined by calculating the maximum current expected in the PV system, and the maximum overcurrent protective device specification is the mandatory requirement of the IEC 61215 and IEC 61730 standards.

For monofacial modules, the string fuse rating should not exceed the maximum sting fuse rating listed in the corresponding datasheet.

For bifacial modules, the following method can be applied to determine an appropriate rating (X):

Minimum string fuse rating < X ≤ Maximum string fuse rating

The maximum string fuse ratings can be found in datasheets and nameplates for all the certified Thornova Solar module types.

The minimum string fuse rating for compliance with NEC: 2017 code and IEC 62548: 2016 requirement is suggested to be determined as follows:

$$\text{Minimum string fuse rating} = I_{scSTC} \times 1.25 \times \text{Max} (1.175, I_{mpp\alpha} \div I_{mppSTC})$$

$I_{mpp\alpha}$ = the highest 3-hour current average resulting from the simulated local simultaneous irradiances on the front and rear sides of the PV array accounting for elevation and orientation.

I_{scSTC} = the listed short circuit current at 0% bifacial gain on the PV module datasheet or nameplate label.

I_{mppSTC} = the listed MPP operating current at 0% bifacial gain on the PV module datasheet or nameplate label.

4. STORAGE, TRANSPORTATION AND DISMANTLING

Precautions and general safety rules:

The modules should be stored in the original Thornova Solar package before installation. Protect the package from damage. Unpack the modules as per the recommended unpacking procedures. The whole process of unpacking, transport and storing should be handled with care.

Do NOT stand, climb, walk or jump on unpacked pallets of modules.

Before installation, ensure that all modules and electrical contacts are clean and dry.



If the modules are required to be stored temporarily, they should be stored under dry and ventilated conditions.







Unpacking must be carried out by two or more persons at the same time. It is forbidden to use the wires or junction boxes of the modules to carry the modules. Handling the modules requires two or more people with non-slip gloves; Do NOT handle the modules over-head or stack the modules.

Do NOT put the modules in a place that is not supported or stable.

Do NOT allow the modules to get in contact with sharp-pointed objectives to prevent them from scratches, avoiding a direct impact on the safety of modules.

4.1 MARKINGS ON OUTER PACKAGING

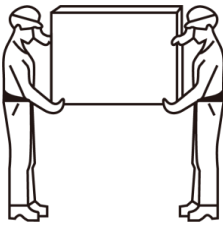



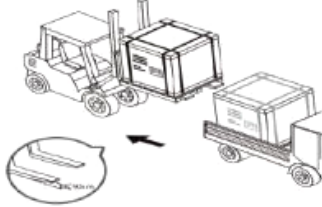
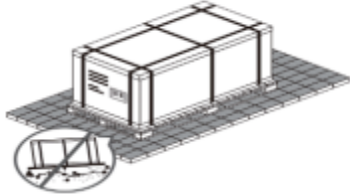
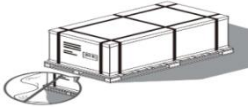
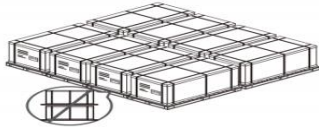
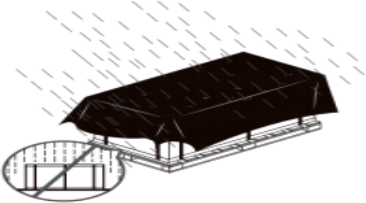

<p>4.1.1 Do NOT discard the modules at will; special recycling is required.</p>  <p>EU-28WEEE COMPLIANT</p>	<p>4.1.2 Modules must be kept dry, not expose to rain or moisture.</p> 
--	--

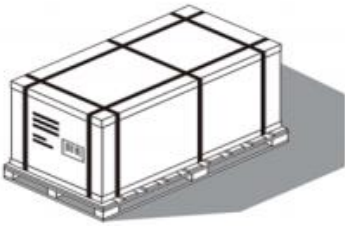

<p>4.1.3</p> <p>Modules in carton are fragile, which must be handled with care.</p> 	<p>4.1.4</p> <p>The packaging must be transported upright.</p> 
<p>4.1.5</p> <p>Do NOT step on the package and module.</p> 	<p>4.1.6</p> <p>The carton can be recycled.</p> 
<p>4.1.7</p> <p>Modules shall be stacked as required, not exceeding the maximum number of layers printed on the outer packaging. (n=2 means no more than two layers and n = 3 means no more than three layers).</p> 	<p>4.1.8</p> <p>One module shall be handled by at least two persons together.</p> 
<p>4.1.9</p> <p>When the carton box is loading and uploading in the transportation. Attention: Prevent collision on the top.</p> 	

4.2 UNLOADING WARNING

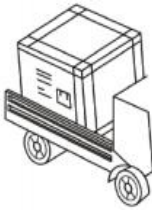
<p>4.2.1</p> <p>Use the correct (as picture) lifting fixture to handle, no more than 2 pallets per lift. Before lifting, please confirm the tray and the carton are NOT damaged and the hoisting rope is firm and solid. Before lowering the carton back on the ground, two persons must support the two sides of the carton gently to put it on a relatively flat place.</p> 	<p>4.2.2</p> <p>If the condition permits, use a forklift to remove the module pallets from the truck.</p>  <p>Put the modules on level ground.</p> 
<p>4.2.3</p> <p>Store the module in a dry and ventilated place.</p> 	<p>4.2.4</p> <p>Do not stack the modules at the project site.</p> 
<p>4.2.5</p> <p>Cover all of parts of the package with waterproof material to prevent the panel package and plate from moisture.</p> 	

4.3 SECONDARY TRANSPORT AND WARNING

<p>4.3.1 Do NOT remove the original packaging if the modules require long-distance transport or long-term storage.</p> 	<p>4.3.2 The finished package can be transported by land, sea or air. During transport, make sure that the package is fixed with packing straps securely to the shipping platform</p> 
<p>4.3.3 Transport: Do Not Stack more than two layers on truck.</p> 	<p>4.3.4 Only one layer stacking is only allowed for small truck. Make sure that the package is fixed with packing straps securely to the shipping platform without movement.</p> 
<p>4.3.5 Only one-layer stacking is only allowed for transport at the project site.</p> 	<p>4.3.6 No transport or handling by pedi-cab as shown below.</p> 

<p>4.3.7 Do Not transport the modules with rope as shown below.</p> 	<p>4.3.8 Do Not carry the modules on the back of one person as shown below:</p> 
---	--

4.4 STORAGE

Long-term storage in warehouse:

Do NOT remove the original packaging if the module requires long-distance transport or long-term storage.

Do NOT expose the modules to rain or moisture. Store the finished product in a well-ventilated, waterproof, dry and smooth place.

Do Not Stack more than 2 layers (moisture < 85%, temperature range from -20°C to + 50 °C)

Storage in project site:

The module must be installed as soon as possible in the project site and must not be exposed to rain or damp.

Thornova Solar shall not be responsible for any damage or collapse of the modules caused by moisture in the packaging.

4.5 UNPACKING INTRODUCTION

For unpacking outdoors, it is prohibited to operate in rainy conditions. Because the carton will become soft and damaged after it gets wet in the rain. The stacked PV modules (hereinafter referred to as "modules") may tip over, which may cause damage or injury to personnel.

For a windy site, it is necessary to pay special attention to safety. Especially, it is NOT recommended to transport the modules in high wind conditions. The unpacked modules must be tied down to avoid any unwanted movement.

The work surface is required to be level to ensure that the package can be placed stably, avoiding sliding.

Wear protective gloves during unpacking to avoid hand injury and fingerprints on the glass surface. Module information and unpacking instructions can be found on the outside of each package. Please read the instructions before unpacking.

Each module shall be handled by two persons. It is forbidden to use the wires or junction boxes of the modules to carry the module. Do Not take the module out of the carton by pulling on the long side frame.

4.6 UNPACKING STEPS OF FRAMED DUAL-GLASS MODULE SERIES

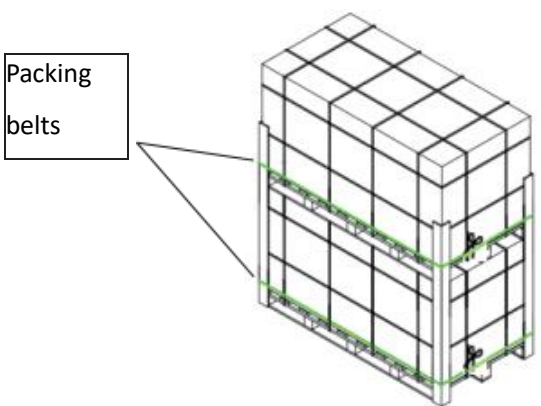
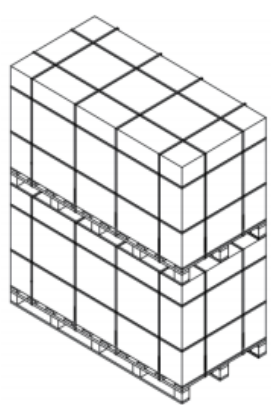
<p>4.6.1 Put the carton box on a level surface. Cutting the packing belts with blade or scissor.</p> 	<p>4.6.2 Taking away 4 plywood protectors</p> 
--	--

4.6.3
Taking down the upper carton box. Before unpacking, please check the product name, serial number and related suggestions on the A4 paper. Please read the unpacking instructions carefully. NO other customized unpacking method is allowed.

Unpacking instructions

A4 paper (product name, serial number, related suggestions, etc.)

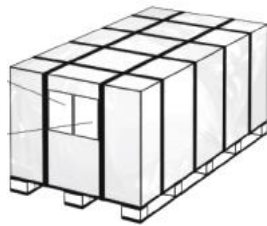

4.6.4
Cut the two packing belts at shorter sides of the tray with blade or scissors and unpack the side surface of the carton along the vertical direction.

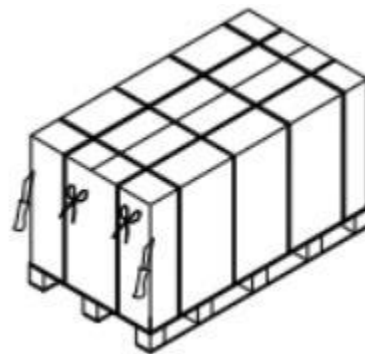

4.6.5
Cut the tape at shorter edge and hold it up by 90° from the bottom; and pull out the cardboard to expose the modules.

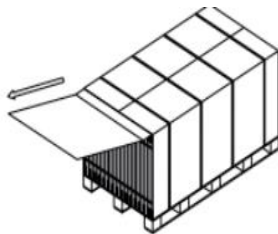

4.6.6
Cut the two horizontal packing belts in the carton and cut the two packing belts near the bottom of the tray, and remove the packing belts

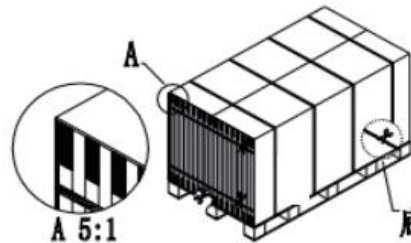

4.6.7
When unpacking on a level surface, take out the module from one side of package to the other, and then carry it with two persons (Please refer to 4.1.8) When unpacking on a sloping surface, please protect the modules from tipping over or sliding. As shown below.

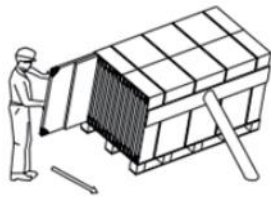

4.6.8
Do NOT lean the module on the mounting posts.



4.6.9 If all the modules are NOT removed after unpacking and some of them are left in the package, the remaining modules shall be laid flat and repackaged to prevent from falling down. Must be placed by horizontal. The stacked number of modules: Stacked NO MORE than 16 pieces.

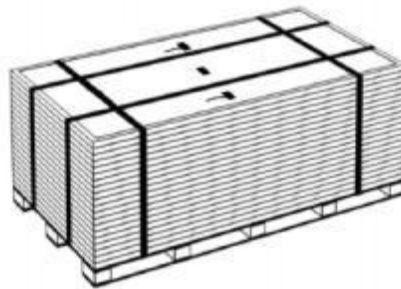

5. MODULE INSTALLATION

Thornova Solar modules may be installed in extreme environmental conditions to produce energy for more than 30 years. In addition to the required IEC certifications, Thornova Solar products have also been tested to verify resistance to ammonia fumes that may be present around barns sheltering cattle, as well as suitability for installation in humid (coastal) areas and areas of high sandstorms (desert).

5.1 PRECAUTIONARY MEASURES AND GENERAL SAFETY

Before installing modules, the relevant authorities should be contacted to obtain information about any requirements and necessary approvals for the site, installation, and inspection.

Check applicable building codes to ensure that the construction or structure (roof, facade, support, etc.) has sufficient load-bearing capacity for the module system.

Thornova solar modules have been certified for Application Class A (equivalent to Safety Class II requirements). Such modules can be used in systems with voltages greater than 50V or powers greater than 240W that are likely to be exposed to the public.

Thornova Solar double glass modules have been certified as Type 29 in accordance with UL 61730 and as Class A in accordance with IEC 61730-2 for fire performance. Single glass monofacial modules have been certified as Type 1 in accordance with UL 61730 and as Class C in accordance with IEC 61730-2. Please refer to the datasheet or the product nameplate for the specific types.

ENVIRONMENTAL CONDITIONS

PV modules are suitable for use in general open-air climates, with reference to IEC 60721-2-1: Classification of environmental conditions Part 2-1: Environmental conditions appearing in nature-Temperature and humidity.

Please consult the Thornova Solar technical support department in advance for more information if modules are used in special climates, such as an altitude above 2000 m, heavy snow, severe hailstorm, hurricane, etc.

Module installation near open flames or flammable materials is forbidden.

Do not immerse modules in water or expose modules to water for a long time (either pure water or salty water, e.g. from fountains, sea spray).

Exposing modules to salt atmosphere (i.e. marine environments) or sulfur (i.e. sulfur sources, volcanoes) will increase the risk of module corrosion.

Do not expose modules and their connectors to any unauthorized chemical substances (e.g. lubricant, pesticide, etc.), as it causes module damages.

INSTALLATION REQUIREMENTS

- Make sure that the module meets the overall technical system requirements.
- Make sure that components of other systems do not cause the mechanical or electrical damage to the module.

Allow modules to be wired in series to increase voltage or in parallel to increase current. When in series, the cables from the positive terminal of one module are connected to the negative terminal of the next module. When in parallel, the cables from the positive terminal of one module are connected to the positive terminal of the next module.

The quantity of bypass diodes in the module junction box provided may be different depending on the model types.

Connect the appropriate quantity of modules according to the voltage specification of the inverter used in the system. In addition, connecting modules together to create a voltage higher than the maximum permitted system voltage indicated on the nameplate is forbidden, even under the worst local temperature conditions. A maximum of two strings can be connected in parallel if no over-current protection device (fuses) is used in series within each string. Three or more strings can be connected in parallel if an appropriate and certified over-current protection device is installed in series within each string. And the PV system design must ensure that the reverse current of each single string is below the module maximum fuse rating in any case.

To avoid (or reduce) the mismatch effect in arrays, it is recommended that modules with similar electrical properties be connected in the same string.

To reduce the risk of indirect lightning strikes, the system should be designed to avoid forming loops with wires.

Modules should be securely fixed to sustain all possible loads, including wind and snow loads.

Taking into account the thermal expansion effect between the frames and modules, a minimum gap between modules is necessary, which is 6.5 mm (0.25 in).

The drain holes on modules must not be blocked.

OPTIMUM ORIENTATION AND TILT

To achieve the maximum annual power generation, please first determine the optimal orientation and tilt for PV modules installation. The maximum electrical energy is usually generated when sunlight shines vertically onto the PV modules.

AVOID SHADING

In no case shall modules be permanently obscured (including surface partial shading, spot shading, even shading or uneven shading). Permanent shading means that shading repeatedly appears on the same piece of cell, the same row of cells or the same area of modules for extended periods of time, such as installing modules in the backlight of a pipe or a chimney, etc. If a flaw (e.g. a hot spot) is caused by a panel being installed incorrectly in the shade or due to poor maintenance, it will void Thornova Solar's warranty.

Completely or partially shaded cells will result in no photovoltaic conversion, reducing the output performance and can cause localized overheating, which in turn may significantly shorten the module service lifetime. Additionally, permanent shading may accelerate EVA aging process and exacerbate long-time uninterrupted heating on the bypass diodes. Therefore, the module's warranty would be voided unless the negative effects were properly mitigated or eliminated through the use of Module Level Power Electronic (MLPE) devices.

Regular and frequent maintenance should be carried out to keep modules clean. Particular measures should be carried out to avoid permanent cover caused by dirt or debris (e.g., leaves, tree branches, bird droppings, etc.).

NOTICE Permanent shading will affect the module service lifetime and void Thornova Solar's warranty!

- It should be ensured in the PV system design that the modules are not installed directly behind any object.
- The PV system has to be cleaned regularly to avoid permanent shading by dirt or debris.

NOTICE Temporary shading will reduce yield!

- To minimize risk in the event of even or uneven shading from the front row of PV modules or nearby objects (e.g., front parapet wall, chimney, tree, electric wire, etc.) when designing the PV system.

Do not install modules directly behind any building (such as chimney) or trees to avoid permanent shading.

Even temporary partial shading will cause a drop in the power generation. A module can be considered as unshaded if it is not obscured throughout the year, sunlight being guaranteed to reach the modules even on the shortest day of the year.

In order to maximize the power generation on the back side of bifacial photovoltaic modules, the obstruction on the back side of the bifacial photovoltaic module should be avoided to the greatest extent.

RELIABLE VENTILATION

In general, there should be sufficient clearance (at least 102 mm, 4.0 in) between the underside of the module and the mounting surface to ensure that cooling air can circulate in the rear space of the module, while also allowing condensation or moisture to dissipate.

6. MOUNTING INSTALLATION



- The applicable laws and regulations concerning work safety, accident prevention and construction site safety must be observed. Workers and third-party personnel shall wear or install safety equipment to prevent falling from height. Any third-party injuries or property damages should be prevented. The mounting design must be certified by a registered professional engineer. The mounting design and procedures must comply with all applicable local codes and requirements from all relevant authorities.
- The module is considered to comply with UL 61730 and IEC 61215/61730 only when the module is installed in accordance with the installation instructions described in this installation manual or a written statement approved by Thornova Solar. The system designer and installer are responsible to calculate loads and proper design of support structure.
- The mechanical loads in this manual are guaranteed load values based on the installation of supporting structures and fixed parts with a carrying capacity not less than that of the mechanical loads. The installation system supplier is responsible for the strength and stability of the installation structure, which must meet the relevant design specifications.
- The loads described in this manual are test loads. A safety factor of 1.5 times should be taken into

account when calculating the corresponding maximum authorized design loads according to the installation requirements of UL 61215/61730. The design loads for a project depend on the project location, local climate, the structure of the bracket and the relevant norms. It is the responsibility of the racking suppliers and specialist engineers to determine the design loads. For more detailed information, please follow local laws and regulations as well as the instructions of your professional engineer.

$$\text{Test Load} = 1.5(\text{Safety Factor}) \times \text{Design load}$$

- Load distribution on the module area is not balanced. Wind and snow loads are unevenly distributed on the module's surface, and such must be considered in the definition of the PV module design load and the respective constraints of the mounting system. The test load values shown in this manual are uniform loads. The maximum allowable unbalanced design load (P_{max}) must be less than 0.8 (unbalanced factor) \times Test load.

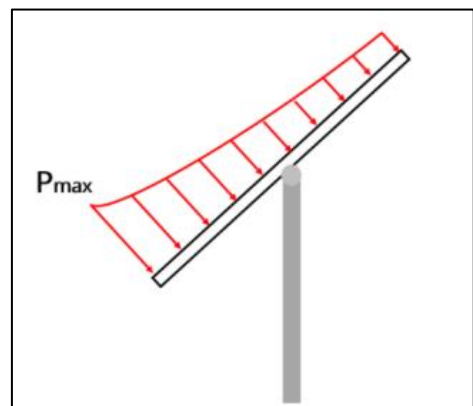

- During installation, the components below the module need to be inspected to ensure the surface is free of zinc slag protrusions or burrs, aiming to avoid damage to the glass or backsheets. Do not drill additional holes or modify the module frame. Such behavior will void the module's warranty.
- Use appropriate corrosion-resistance fasteners. All fasteners installed (bolts, spring washers, flat washers, nuts) should be hot dip galvanized or stainless steel. Install and tighten on the mounting rail using the torque specified by the mounting hardware manufacturer. Recommended accessories are shown below:

Accessory	Model	
Bolt	M8 x 1.25-Grade 8.8 (5/16"-18 Grade B7) galvanized or A2-70 stainless steel coarse thread bolts.	M6 X 1 (1/4") coarse thread bolts
Washer	2 pcs, thickness ≥1.5mm and outside diameters = 16mm	2 pcs, thickness ≥1.5mm and outside diameters =12 - 16mm
Spring washer	8	6
Nut	M8	M6

Note that:

1. According to bolt classes, M8 and M6 bolt tightening torques must be within 16~20 Nm (11.8~14.75 ft-lbs) and 6~9 Nm (4.5~6.6 ft-lbs), respectively. The technical guidelines provided by the fastener suppliers should be followed for bolt grades. Priority should be given to different recommendations from specific clamping hardware suppliers.
2. The yield strength of bolts and nuts shall not be less than 450 MPa.

Bolt locations on the module, where M6 bolts are used only in single-axis tracker

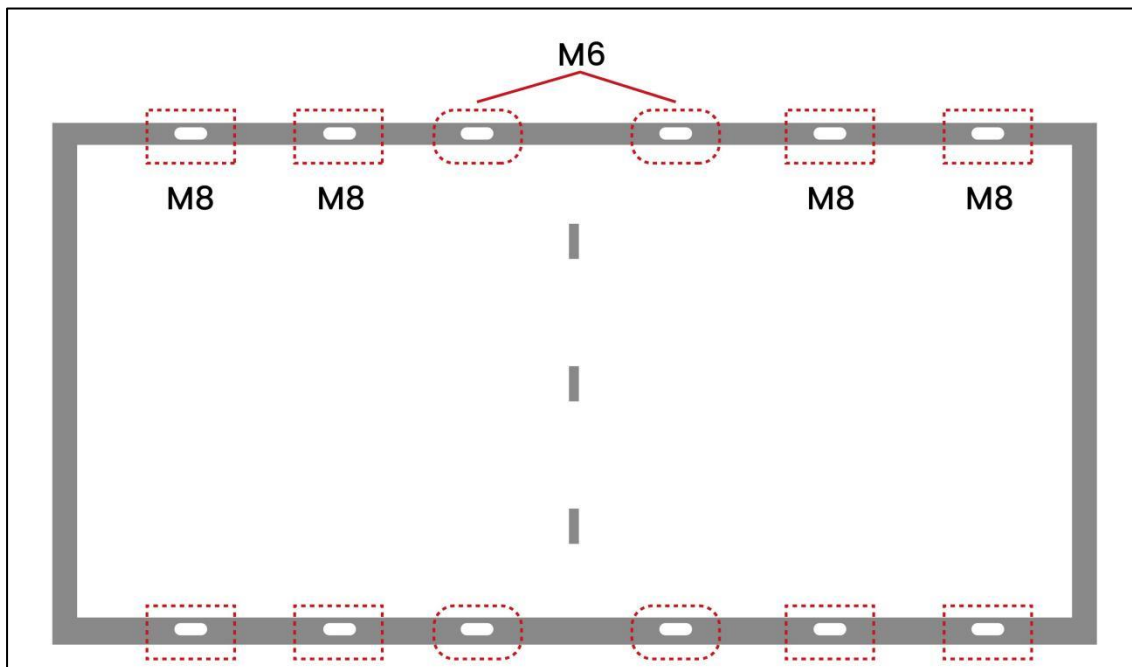

Due to gravity, the laminate of the PV modules will have different degrees of subsidence, with the maximum amount of subsidence at the center of the module. The maximum permissible deflection (ΔL in the figure below) is 20 mm when using bolting or clamping mounting method or insertion system without external forces such as wind or snow loads. Please note that when storing, transporting and installing the module, applying external heavy pressure on the surface of the module may cause the glass surface to sink more.

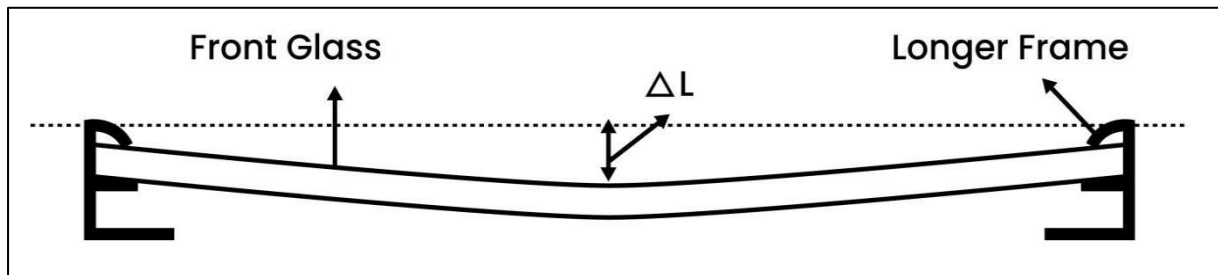

6.1 MOUNTING METHOD: BOLTING

- The mechanical load test with these mounting methods were executed according to IEC 61215. Modules should be bolted to the supporting structures through the mounting holes in the rear frame flanges only. Each module must be securely fastened at least 4 points on two opposite sides.
- Appropriate bolt length should be selected based on actual module frame height. For double glass modules with a bezel height of 30mm, we recommend a maximum bolt length of 20mm in order to properly insert the bolts through the mounting hole. The system designer is responsible for confirming that the bolt lengths specified by the racking supplier meet the above requirements and do not interfere with the installation.
- In areas with heavy wind loads, additional mounting points should be used. The system designer and the installer are responsible for correctly calculating the loads and ensuring that the supporting structure meets all the applicable requirements.

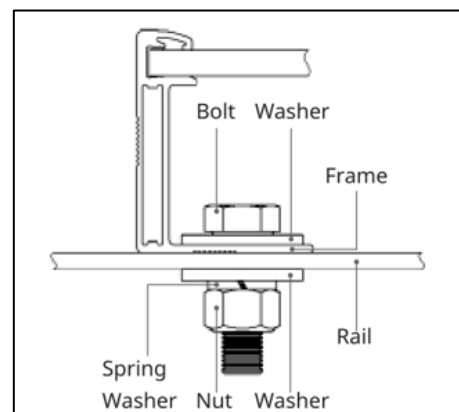

Approved bolting methods

Inner four holes installation method (S-I)

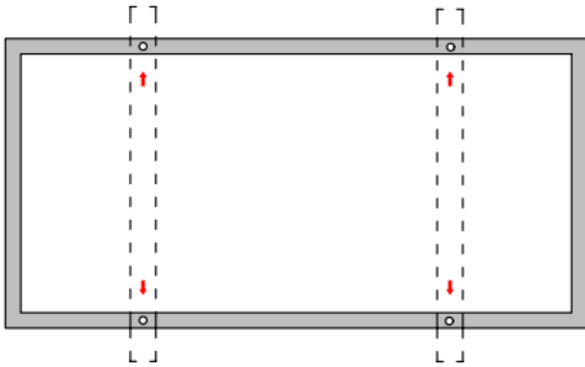

Inner four holes installation method (L-I)

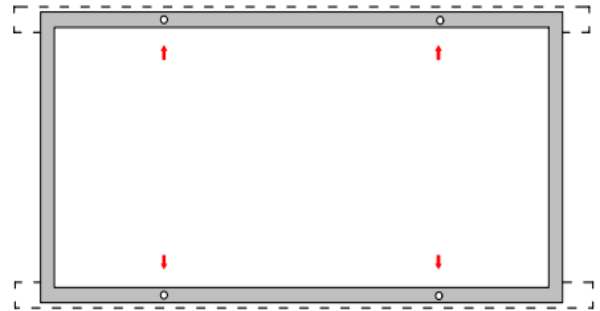

Middle four holes installation method (S-M)

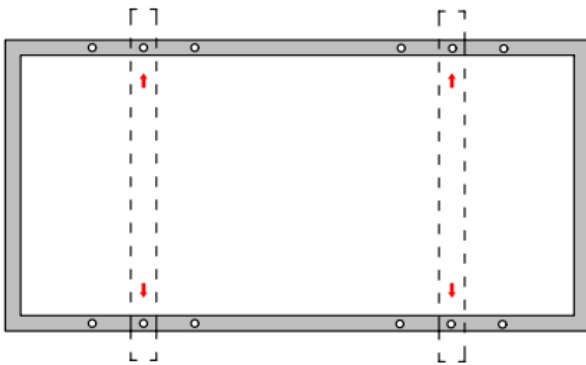

Middle four holes installation method (L-M)

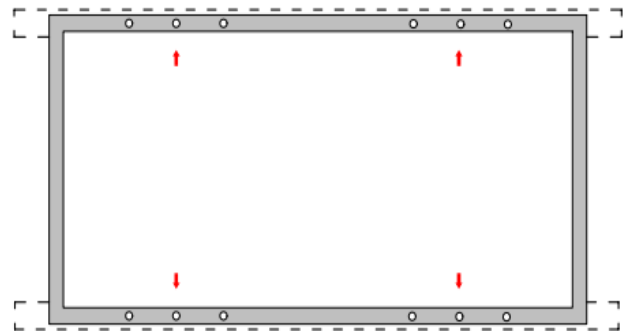

Outer four holes installation method (S-O)

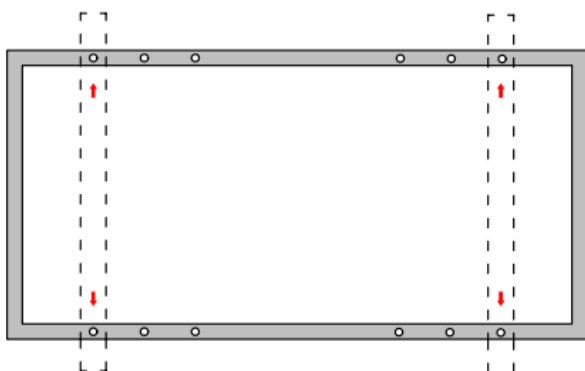

Outer four holes installation method (L-O)

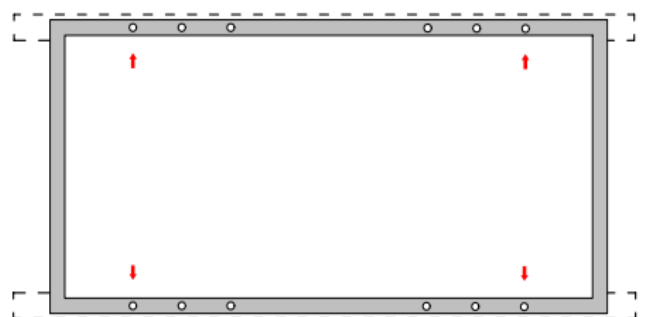

***See attachment 1 for module naming description.**

Module*	Frame Dimension	S-I	S-M	S-O	L-I	L-M	L-O
TS-BB/BW54 TS-BBT/BWT54	1722x1134	+5400/ -2400	N/A	N/A	+5400/ -2400	N/A	N/A
TS-BG54 TS-BGT54	1722x1134	+5400/ -2400	N/A	N/A	+5400/ -2400	N/A	N/A
TS-BB/BW60 TS-BBT/BWT60	1903x1134	+5400/ -2400	N/A	N/A	+5400/ -2400	N/A	N/A
TS-BG60 TS-BGT60	1903x1134	+5400/ -2400	N/A	N/A	+5400/ -2400	N/A	N/A
TS-BB/BW66 TS-BBT/BWT66	2094x1134	±1800	+5400/ -2400	+5400/ -2400	N/A	±2400	+5400/ -2400
TS-BG66 TS-BGT66	2094x1134	±1800	+5400/ -2400	+5400/ -2400	N/A	±2400	+5400/ -2400
TS-BB/BW72 TS-BBT/BWT72	2278x1134	±1800	+5400/ -2400	+5400/ -2400	N/A	±2400	+5400/ -2400
TS-BG72 TS-BGT72	2278x1134	±1800	+5400/ -2400	+5400/ -2400	N/A	±2400	+5400/ -2400
TS-BB/BW78 TS-BBT/BWT78	2465x1134	+5400/ -2400	+5400/ -2400	N/A	±2400	+5400/- 2400	+5400/ -2400
TS-BG78 TS-BGT78	2465x1134	+5400/ -2400	+5400/ -2400	N/A	±2400	+5400/- 2400	+5400/ -2400
TS-BBT/BWT48-G11	1762x1134	+5400/ -2400	N/A	N/A	+5400/ -2400	N/A	N/A
TS-BGT48-G11	1762x1134	+5400/ -2400	N/A	N/A	+5400/ -2400	N/A	N/A
TS-BBT/BWT54-G11	1961x1134	+5400/ -2400	N/A	N/A	+5400/ -2400	N/A	N/A
TS-BGT54-G11	1961x1134	+5400/ -2400	N/A	N/A	+5400/ -2400	N/A	N/A
TS-BBT/BWT60-G11	2172x1134	±1800	+5400/ -2400	+5400/ -2400	N/A	±2400	+5400/ -2400
TS-BGT60-G11	2172x1134	±1800	+5400/ -2400	+5400/ -2400	N/A	±2400	+5400/ -2400
TS-BBT/BWT66-G11	2382x1134	N/A	+5400/ -2400	+5400/ -2400	N/A	±2400	+5400/ -2400
TS-BGT66-G11	2382x1134	N/A	+5400/ -2400	+5400/ -2400	N/A	±2400	+5400/ -2400
TS-BBT/BWT66-G12	2384x1303	N/A	+5400/ -2400	+5400/ -2400	N/A	±2400	+5400/ -2400
TS-BGT66-G12	2384x1303	N/A	+5400/ -2400	+5400/ -2400	N/A	±2400	+5400/ -2400

6.2 MOUNTING METHOD: CLAMPING

- Thornova Solar has tested its modules with several clamps from different manufacturers and recommends the use of fixing bolts of at least M8. The clamp shall not break down due to deformation or corrosion during loading. Clamps with length ≥ 50 mm (1.97 inch) and with thickness ≥ 4 mm (0.16 inch), aluminium alloy 6005-T6, Rp0.2 ≥ 225 MPa, Rm ≥ 265 MPa are recommended. (The clamp shall be chosen to guarantee the reliability of module installation. The recommended torque range is for reference only).
- Clamping methods vary depending on the mounting structures. Please follow the mounting guidelines recommended by the mounting system supplier.
- Each module must be securely fastened at least four points on two opposite sides. The clamps should be arranged symmetrically in pairs. The clamps should be mounted in the authorized position ranges defined in the tables below. Install and tighten the module clamps to the mounting rails using the torque provided and stated by the mounting hardware manufacturer.
- System designers and installers are responsible for calculating loads and selecting suitable support structures.
- For bifacial modules, the mounting rails should be designed to avoid shading the back of the module as much as possible.
- It may void Thornova Solar's warranty in the cases where improper clamps (For example, the clamp height does not match with the frame height) or unsuitable installation methods are found. When installing intermodules or end-type clamps, please consider the following measures:
 1. Do not bend the module frame.
 2. Do not touch or cast shadows on the front glass.
 3. Do not damage the surface of the frame (except for the clamps with bonding pins).
- Applied torque should refer to mechanical design standard according to the bolt customer is using, for example: M8: 10-14 N.m (90-125 lbf.in)
- The installation method of clamps is shown in the figure below:

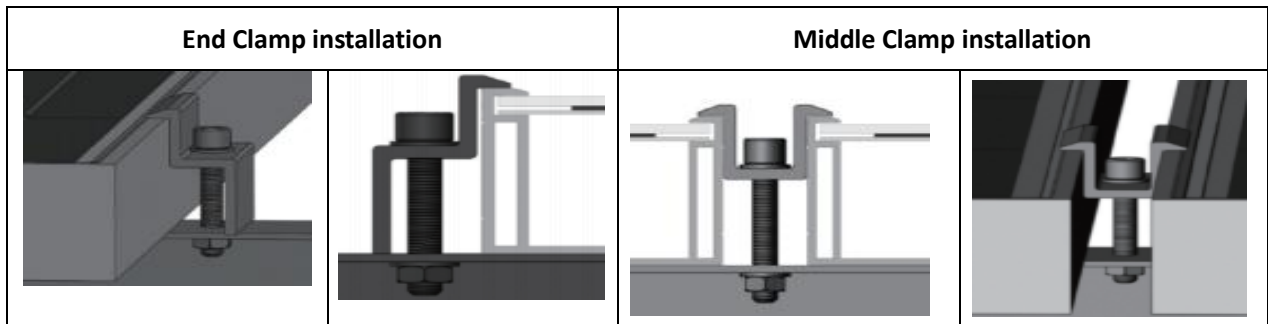

Approved Clamp mounting

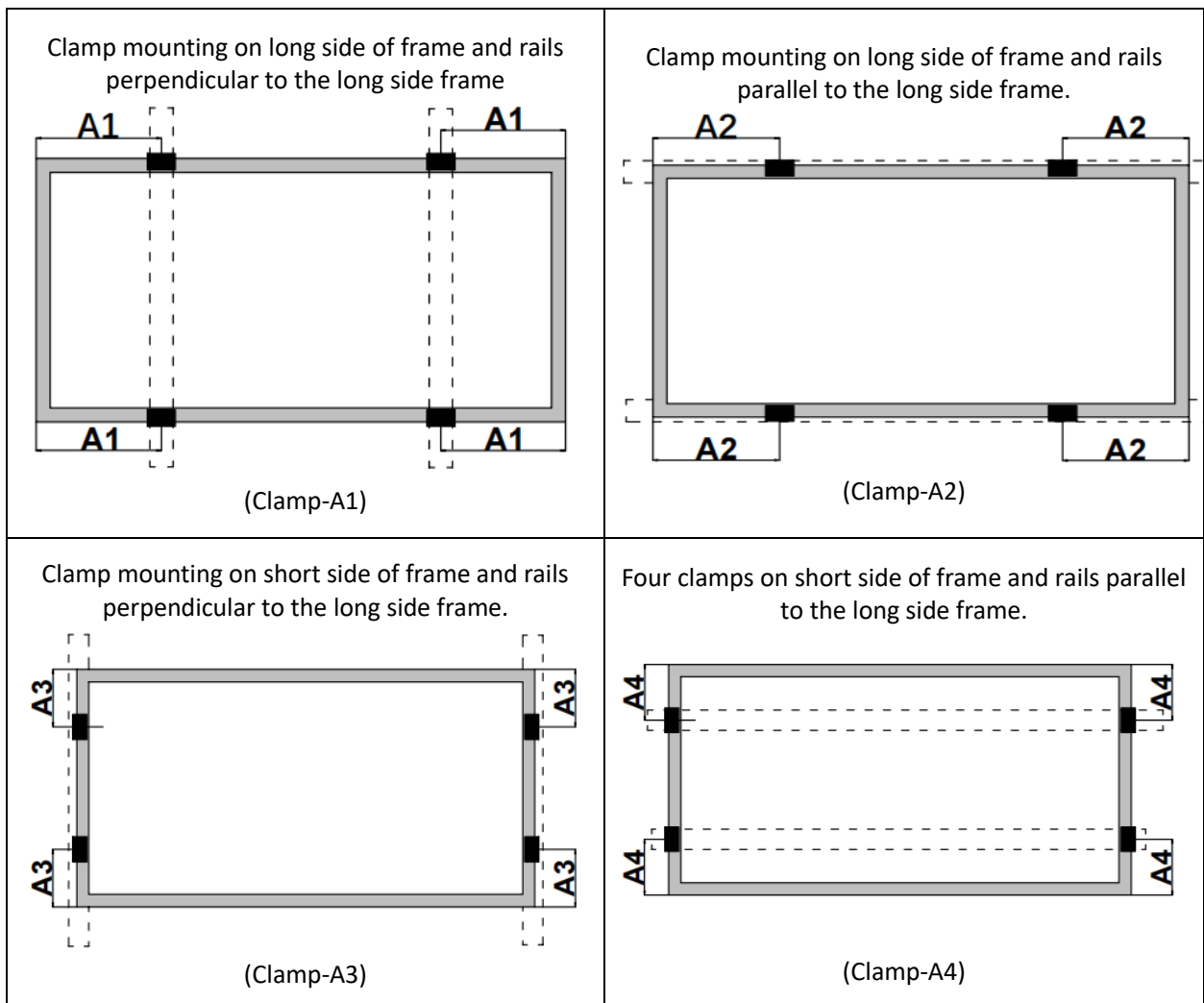

Long side of the frame dimensions abbreviated as L.

Short side of the frame dimensions abbreviated as W.

*See attachment 1 for module naming description.

Module*	Frame Dimension	Clamp-A1 A1=1/4L ± 50mm	Clamp-A2 A2=1/4L ± 50mm	Clamp-A3 A3=1/4W ± 50mm	Clamp-A4 A4=1/4W ± 50mm
TS-BB/BW54 TS-BBT/BWT54	1722x1134	+5400/-2400	±2400	N/A	N/A
TS-BG54 TS-BGT54	1722x1134	+5400/-2400	±2400	N/A	N/A
TS-BBT/BWT48-G11	1762x1134	+5400/-2400	±2400	±1600	+5400/-2400
TS-BGT48-G11	1762x1134	+5400/-2400	±2400	N/A	N/A
TS-BB/BW60 TS-BBT/BWT60	1903x1134	+5400/-2400	±2400	±1600	+5400/-2400
TS-BG60 TS-BGT60	1903x1134	+5400/-2400	±2400	N/A	N/A
TS-BBT/BWT54-G11	1961x1134	+5400/-2400	±2400	±1600	+5400/-2400
TS-BGT54-G11	1961x1134	+5400/-2400	±2400	N/A	N/A
TS-BB/BW66 TS-BBT/BWT66	2094x1134	+5400/-2400	±2400	N/A	N/A
TS-BG66 TS-BGT66	2094x1134	+5400/-2400	±2400	N/A	N/A
TS-BBT/BWT60-G11	2172x1134	+5400/-2400	±2400	N/A	N/A
TS-BGT60-G11	2172x1134	+5400/-2400	±2400	N/A	N/A
TS-BB/BW72 TS-BBT/BWT72	2278x1134	+5400/-2400	±2400	N/A	N/A
TS-BG72 TS-BGT72	2278x1134	+5400/-2400	±2400	N/A	N/A
TS-BBT/BWT66-G11	2382x1134	+5400/-2400	±2400	N/A	N/A
TS-BGT66-G11	2382x1134	+5400/-2400	±2400	N/A	N/A
TS-BB/BW78 TS-BBT/BWT78	2465x1134	+5400/-2400	±2400	±1200	+5400/-2400
TS-BG78 TS-BGT78	2465x1134	+5400/-2400	±2400	N/A	N/A
TS-BBT/BWT66-G12	2384x1303	+5400/-2400	±2400	N/A	N/A
TS-BGT66-G12	2384x1303	+5400/-2400	±2400	N/A	N/A

Note1: The above-described distances are from the module edge to the middle of the clamp.

Note2: Need two or more support rails below the PV module to ensure the mechanical load.

If the customer needs a different size of clamps, it should be fully evaluated and approved by Thornova Solar.

6.3 GROUNDING

All module frames and mounting racks must be properly grounded in accordance with appropriate respective National Electrical Code.

Proper grounding can be successfully carried out by connecting the module frame(s) and all metal structural members together continuously using an applicable grounding conductor. Copper, copper alloy, or any other material acceptable for use can be the grounding conductor or strap as an electrical conductor per respective National Electrical Codes. The grounding conductor must then make a connection to earth using a suitable earth grounding electrode.

Thornova Solar modules can be installed with a third party listed grounding devices to ground the metal frames of PV modules. The devices must be installed according to the grounding device manufacturer's specified instructions.

Please refer to the "Product Catalogue" link for detailed grounding hole locations and size at <http://www.thornovasolar.com>

- Grounding hardware comes in a package that includes the grounding screw, flat washer, star washer and wire.
- Electrical contact is made by penetrating the anodized coating of the aluminum frame and tightening the mounting screw (come with the star washer) to the proper torque of 25lbf.in.
- Grounding wire size (6 to 12 AWG solid bare copper) should be selected and installed underneath the wire binding bolt.

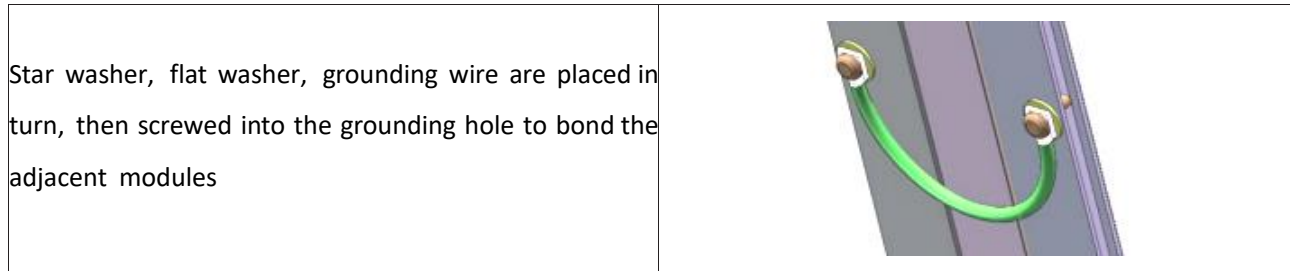

Thornova Solar recommends using the following methods to ground modules properly under UL investigation.:

Method 1: Tyco grounding bolt

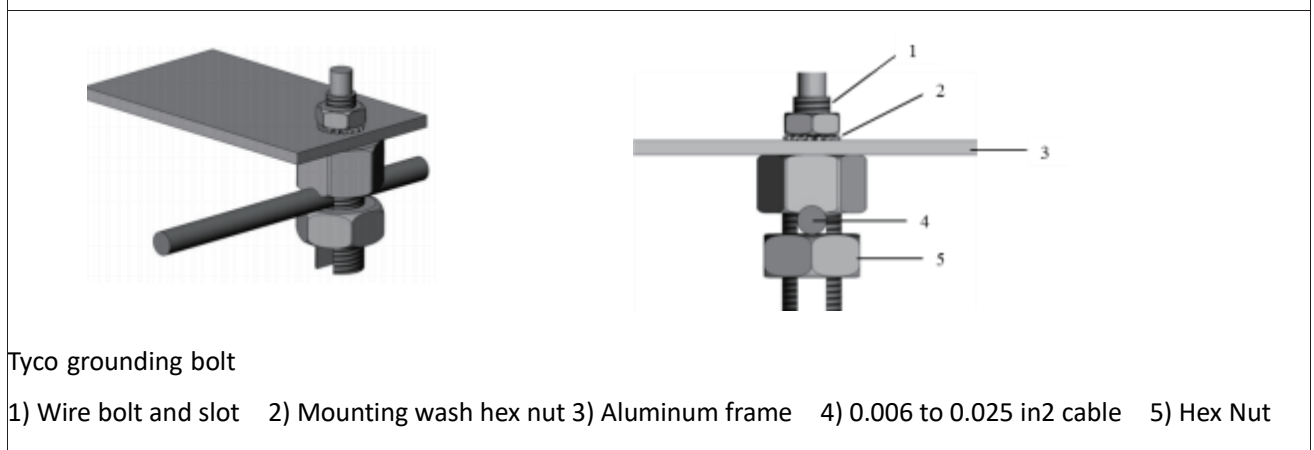

Tyco grounding hardware comes in a package that includes the grounding bolt, mounting and grounding hex nut. Electrical contact is made by penetrating the anodized coating of the aluminum frame and tightening the mounting hex nut (come with the star washer) to the proper torque of 25lbf.in.

Grounding wire size (6 to 12 AWG solid bare copper) should be selected and installed underneath the wire binding bolt.

The wire binding bolt should be tightened to the proper torque of 45lbf.in.

Method 2: Tyco grounding bolt

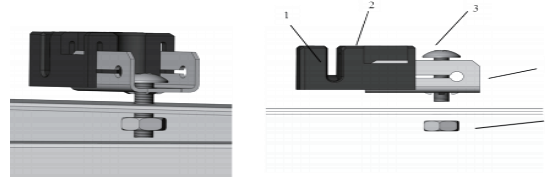

Tyco grounding bolt

- 1) Wire slot (available for 0.006 to 0.025 in² cable) 2) Slider 3) Bolt 4) Base 5) Nut

Tyco grounding hardware comes in a package that includes the grounding bolt, mounting and grounding hex nut.

Electrical contact is made by penetrating the anodized coating of the aluminum frame and tightening the mounting hex nut (come with the star washer) to the proper torque of 25lbf.in.

Grounding wire size (6 to 12 AWG solid bare copper) should be selected and installed underneath the wire binding bolt.

The wire binding bolt should be tightened to the proper torque of 45lbf.in.

The Tyco grounding bolt is only listed for use with 6 to 12 AWG bare solid copper wire.

Method 3: ERICO grounding bolt

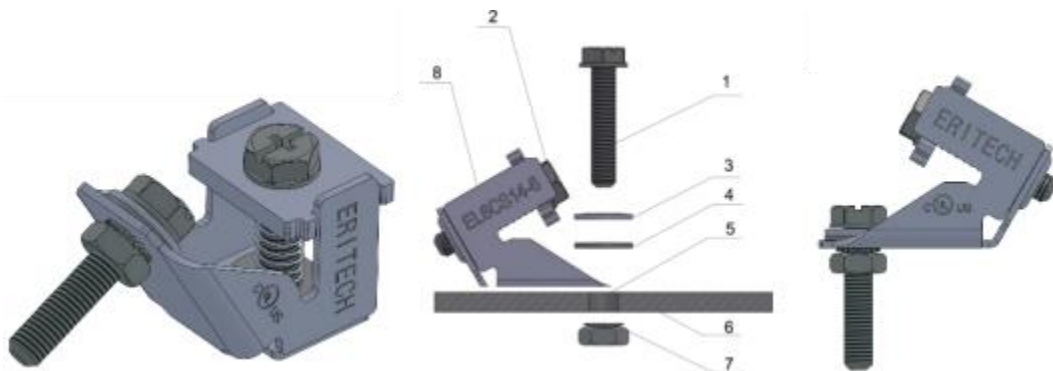

ERICO grounding bolt

- 1) Machine Bolt A 2) Machine Bolt B 3) Belleville washer
 4) Flat Washer 5) Clearance hole for # 10 [M5] machine bolt
 6) Aluminum frame 7) Machine box hex nut with lock washer 8) Grounding bolt

The lug should be installed on a surface that is larger than the bottom surface of the lug. The lug should be installed in the grounding holes provided on the PV module.

Machine bolt A should be torqued to 35lbf.in, to secure the grounding bolt to module frame. The grounding bolt is only listed for use with 6-12 AWG bare solid copper wire.

For proper wire binding, machine bolt B should be torqued to 35lbf.in.

6.4 ELECTRICAL INSTALLATION

All wiring should be performed, by qualified installers, in accordance with the local codes and regulations.

Modules can be connected in series to increase the operating voltage by plugging the positive plug of one module into the negative socket of the next. Before connecting modules always ensure that the contacts are corrosion free, clean and dry.

Product can be irreparably damaged if an array string is connected in reverse polarity to another. Always verify the voltage and polarity of each individual string before making a parallel connection. If you measure a reversed polarity or a difference of more than 10V between strings then check the string configuration before making the connection.

Thornova Solar modules are provided with stranded copper cables with a cross-sectional area of 4mm²(0.006in²) which are UV resistant. All other cables used to connect the DC system should have a similar (or better) specification. Thornova Solar recommends that all cables are run in appropriate conduits and sited away from areas prone to water collection.

The maximum voltage of the system must be less than the maximum certified voltage and the maximum input voltage of the inverter and of the other electrical devices installed in the system. To ensure that this is the case, the open circuit voltage of the array string needs to be calculated at the lowest expected ambient temperature for the location. This can be done using the following formula.

$$\text{Max System voltage} \geq N * \text{Voc} * [1 + \text{TCvoc} * (\text{Tmin} - 25)]$$

Where:

N: Number of modules in series

Voc: Open circuit voltage of each module (refer to product label or data sheet)

TCvoc: Thermal coefficient of open circuit voltage for the module (refer to data sheet)

Tmin: The lowest expected operating temperature of module

Each module has two industry standard 90°C sunlight resistant output cables, each terminated with plug & play connectors. The PV Wire cable and are 12AWG in size. This cable is suitable for applications where wiring is exposed to direct sunlight. Thornova Solar requires that all wiring and electrical connections comply with the appropriate National Electrical Code.

The minimum and maximum outer diameters of the cable are 5 to 7mm (0.038 to 0.076in2).

For field connections, use at least 4mm² copper wires insulated for a minimum of 90°C and sunlight resistance with insulation designated as PV Wire.

The minimum bending radius of the cables must be 43mm (1.69in).

6.5 WIRING

To ensure proper system operation the correct cable connection polarity (Figures 1 & 2) should be observed when connecting the modules to each other or to a load, such as inverter, a battery etc. If modules were not connected correctly, the bypass diodes could be destroyed. PV modules can be wired in series to increase voltage. A series connection is made when the wire from the positive terminal of one module is connected to the negative terminal of the next module. Figure 1 shows modules connected in series. PV modules can be connected in parallel to increase current (Figure 2). A parallel connection is made when the wire from the positive terminal of one module is connected to the positive terminal on the next module.

The number of modules in series and in parallel shall be designed reasonably according to the system configuration.

All instructions above have to be obeyed to maintain Thornova Solar limited warranty.

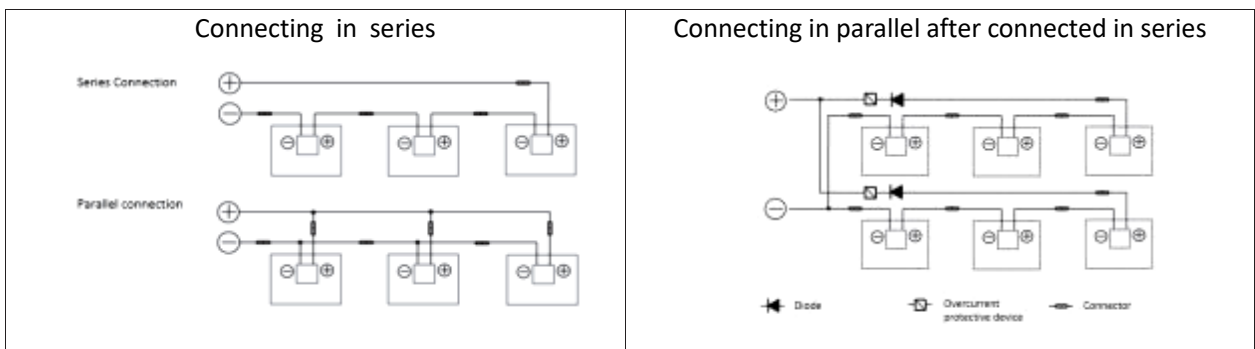

Figure 1 Connection in series

Figure 2. Connection in parallel

When fuses are fitted, they should be rated for the maximum DC voltage and connected in each, non-grounded pole of the array (i.e. if the system is not grounded then fuses should be connected in both the positive and negative poles).

The maximum rating of a fuse connected in series with an array string is typically 25A but the actual module specific rating can be found on the product label and in the product datasheet.

This fuse rating value also corresponds to the maximum reverse current that a module can withstand (when one string is shaded then the other parallel strings of modules will be loaded by the shaded string and current will flow) and therefore impacts the number of strings in parallel.

Do NOT share a fuse in a Combiner Box with two or more strings in parallel connection.

Attachment 1: NAMING RULE

TS - BGTXX (XXX) - GXX – (X) (All Black)

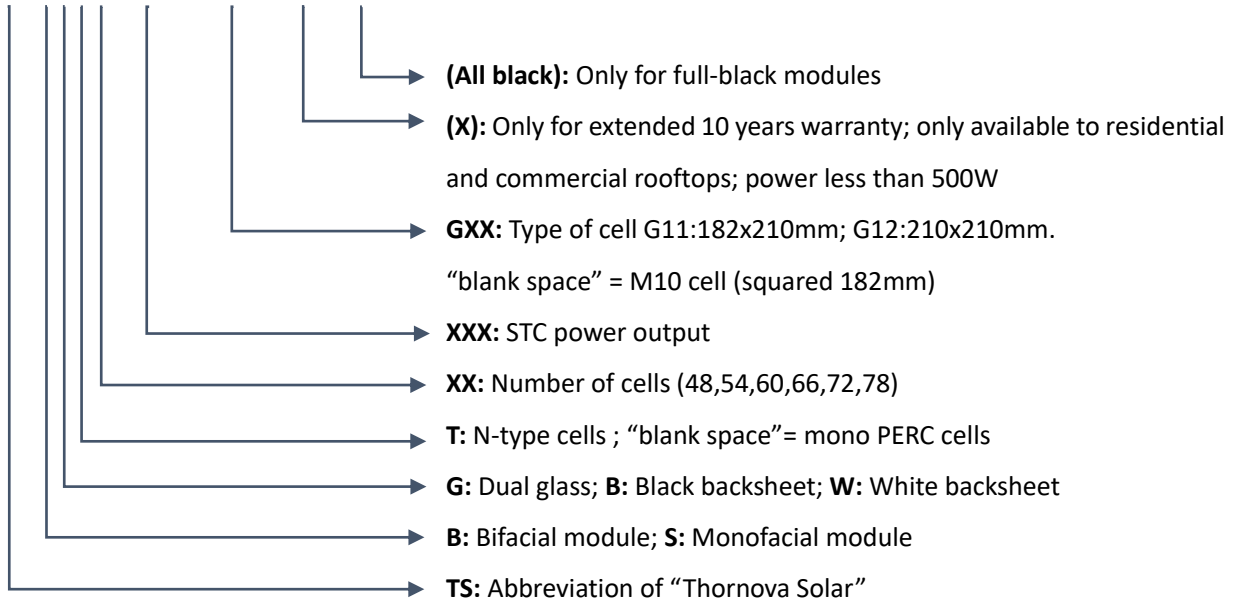

THORNOVA solar